

Coffre 17

Présentation

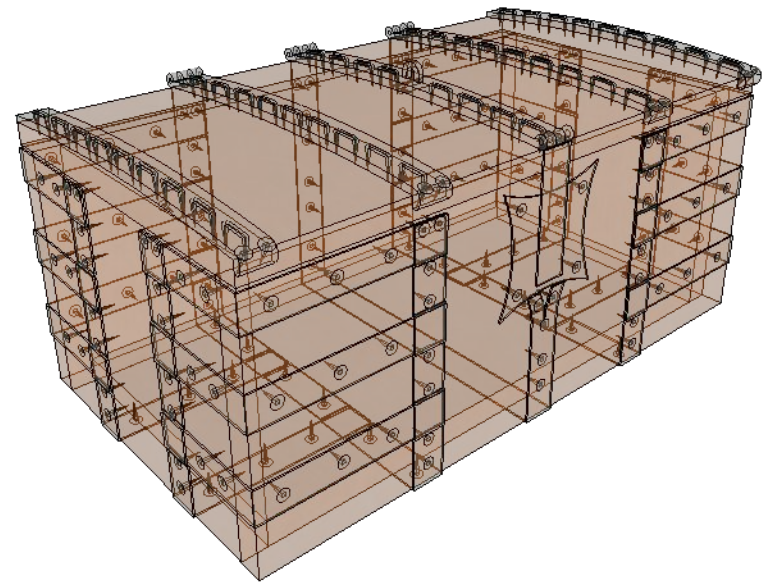
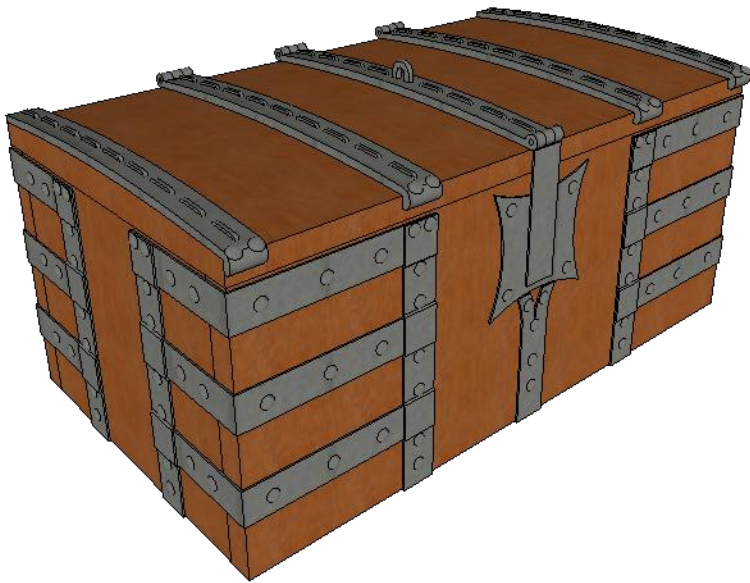

Coffre 17

Présentation

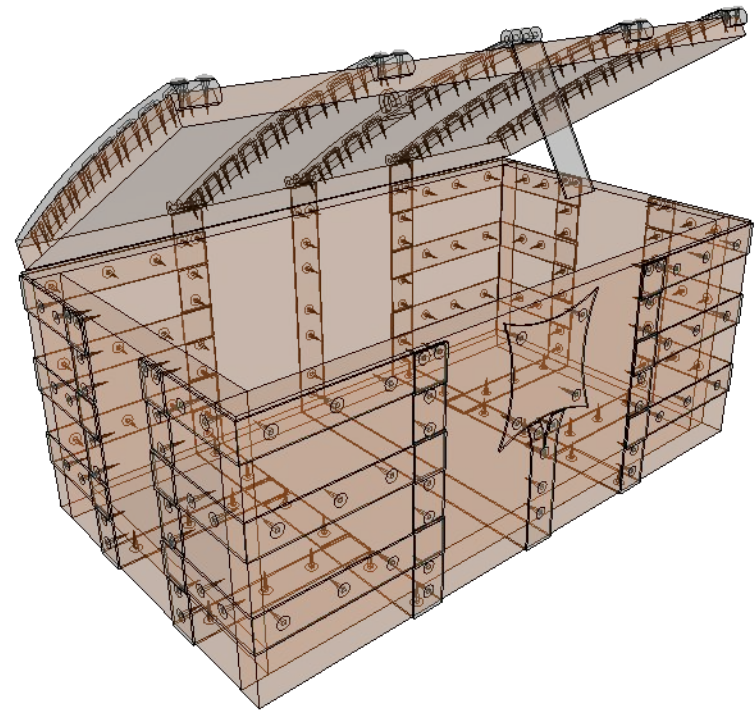
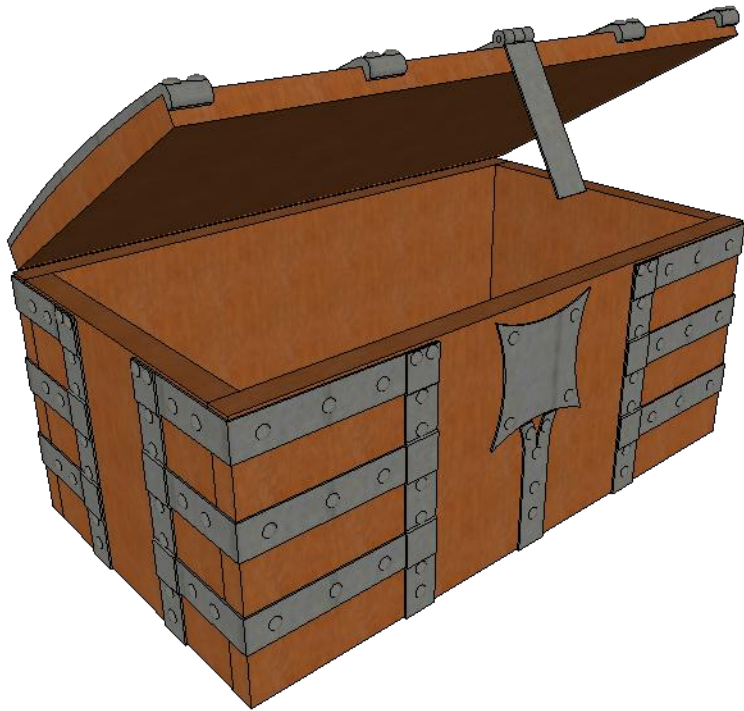

Coffre 17

Présentation

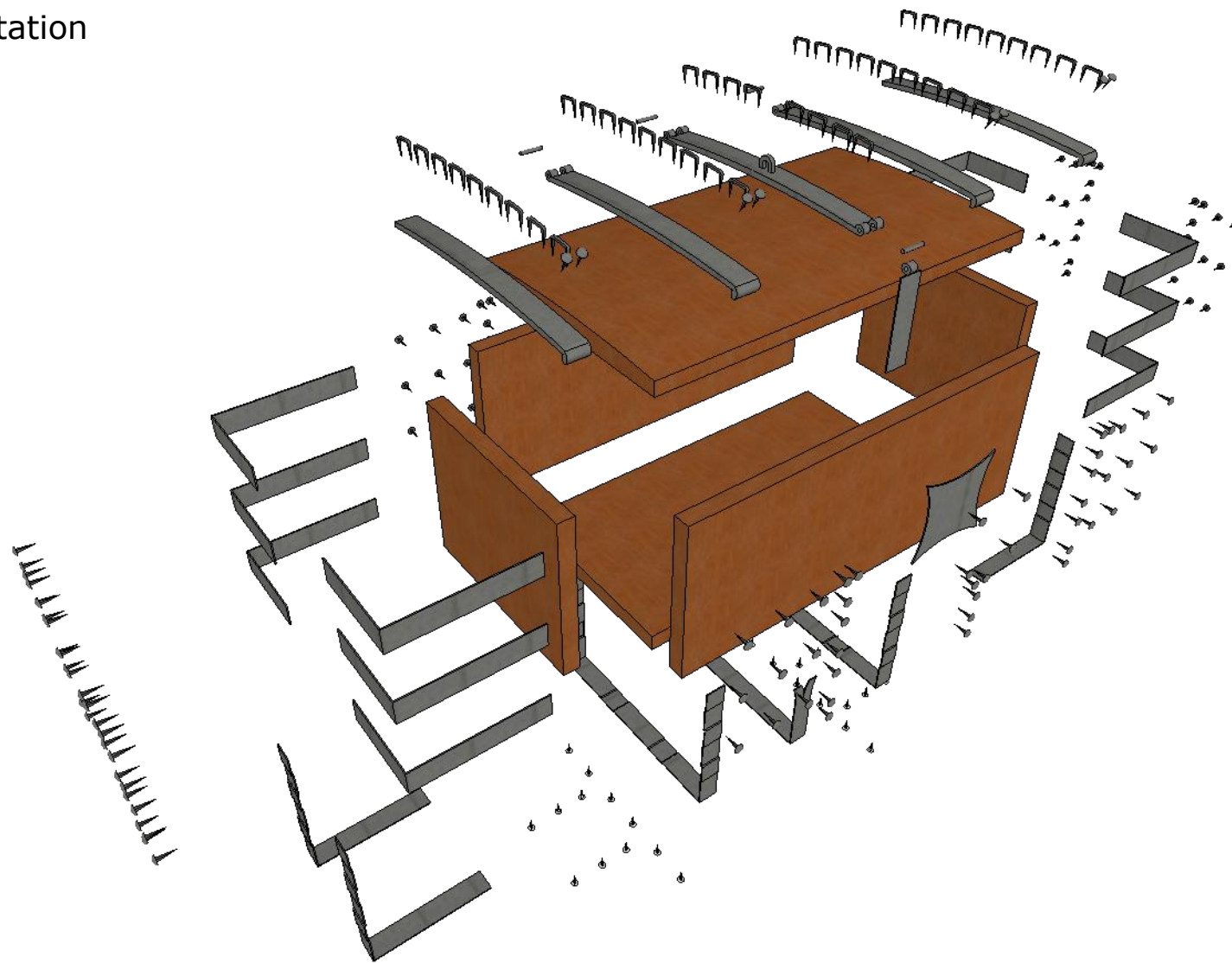

Coffre 17

Présentation

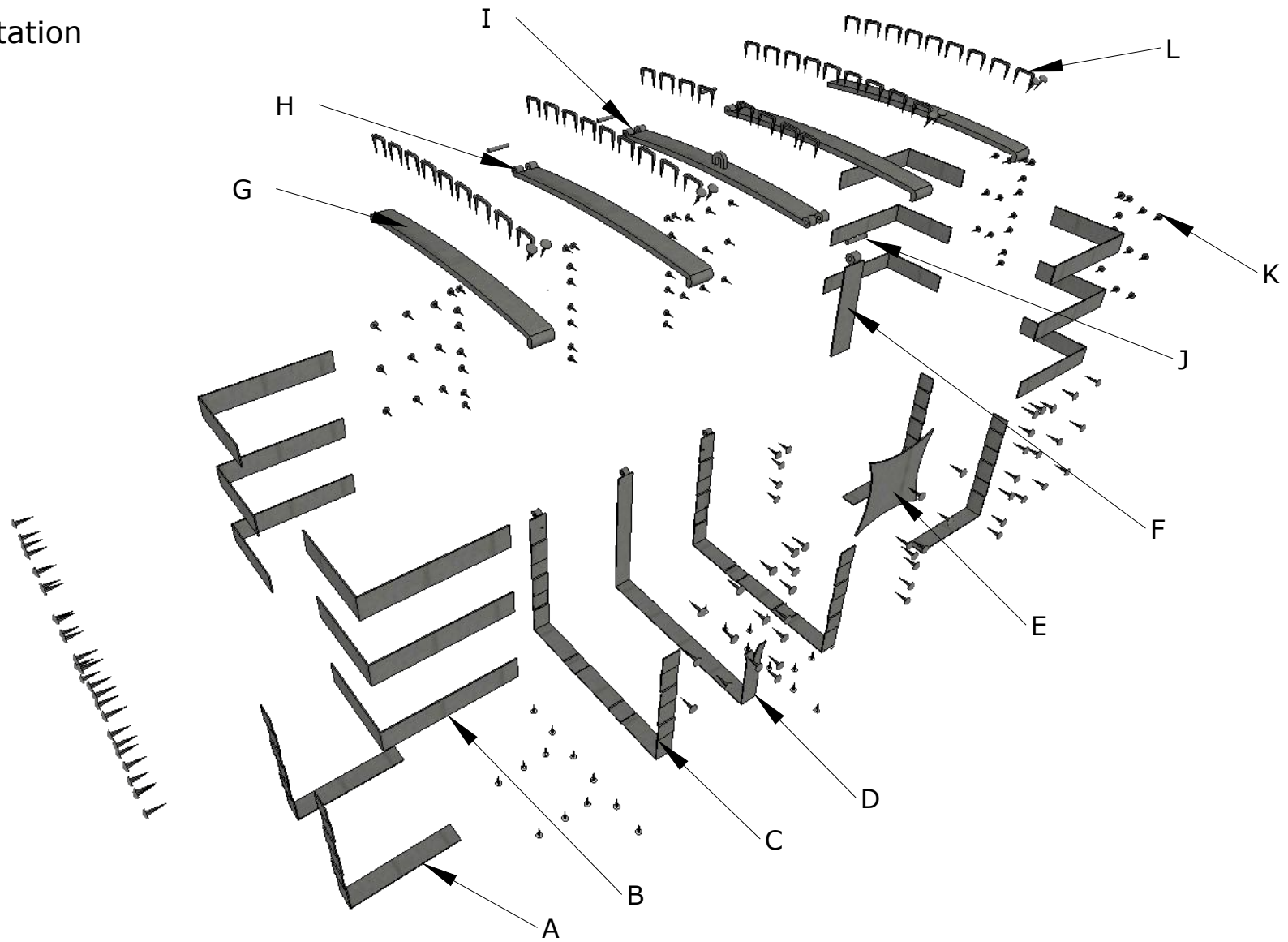

Coffre 17

Présentation

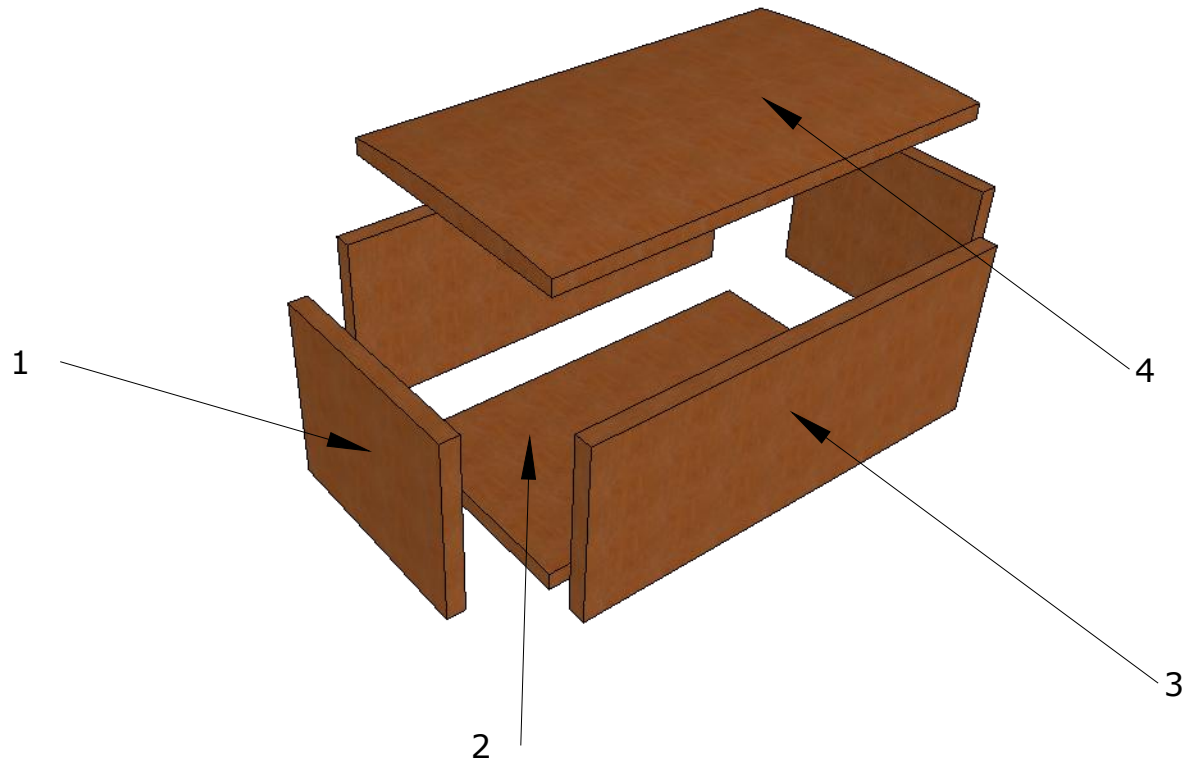

Coffre 17

Présentation

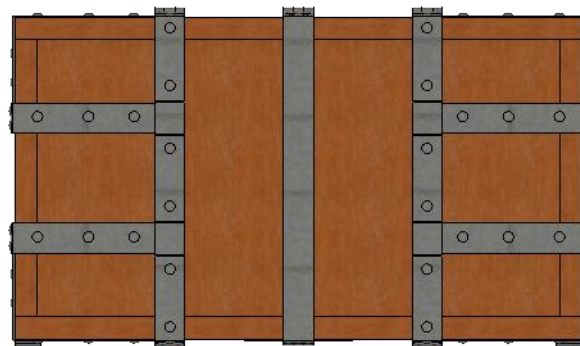
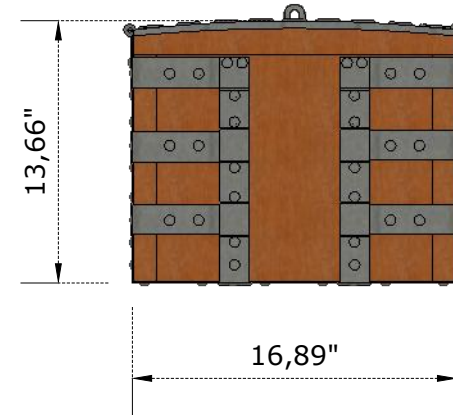
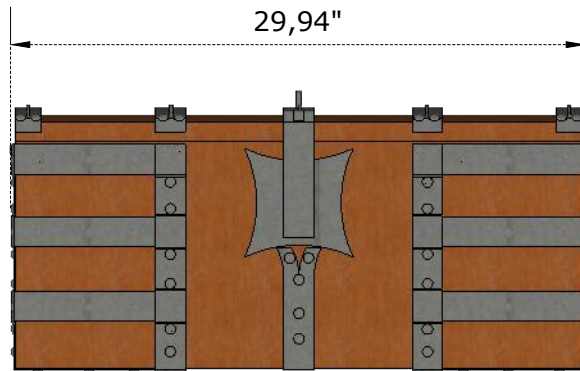
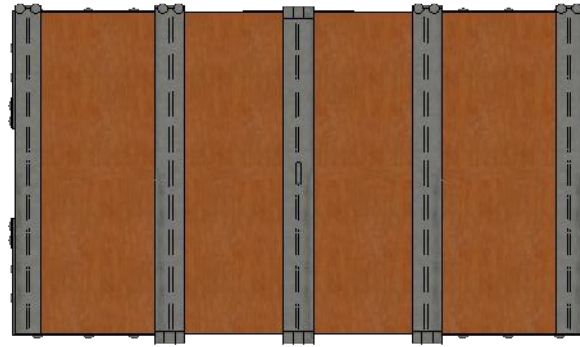

Coffre 17

1 X2

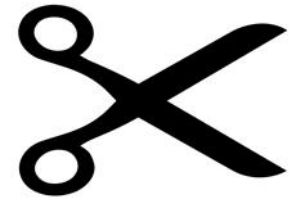

L X44

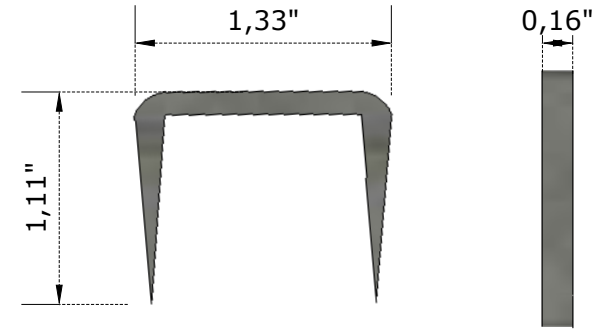

K X173

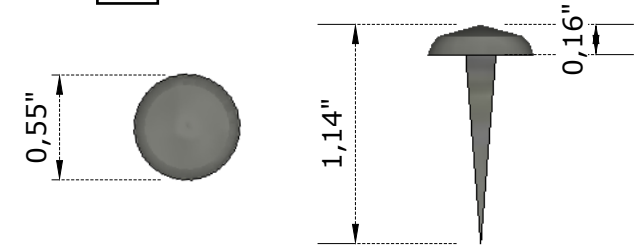

J X4

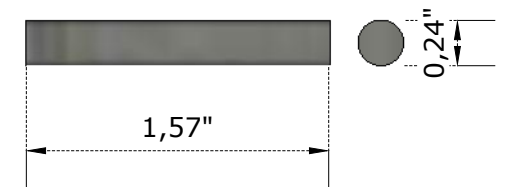

Coffre 17

2



Coffre 17

3 x2



Coffre 17

4



Coffre 17

A X4

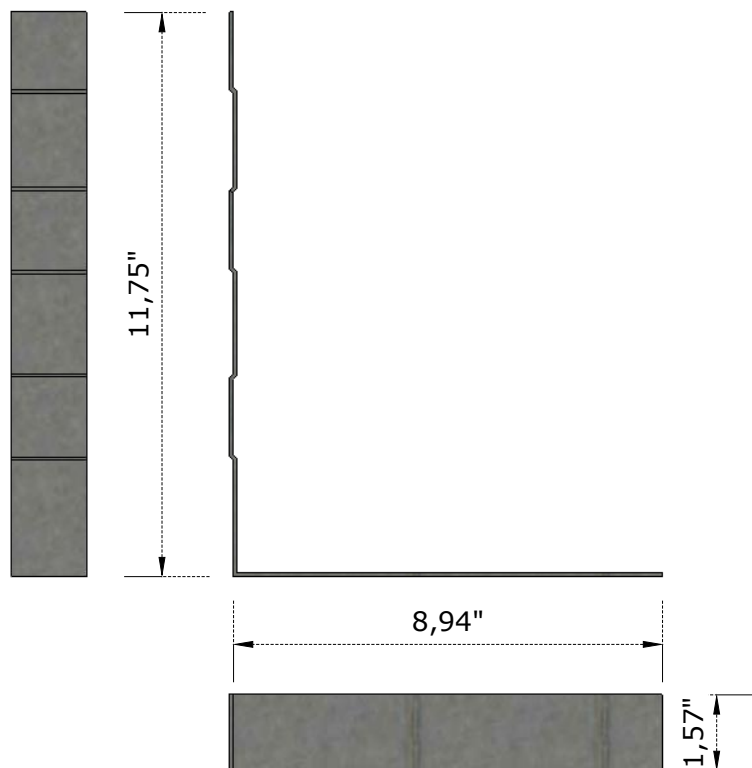

B X6

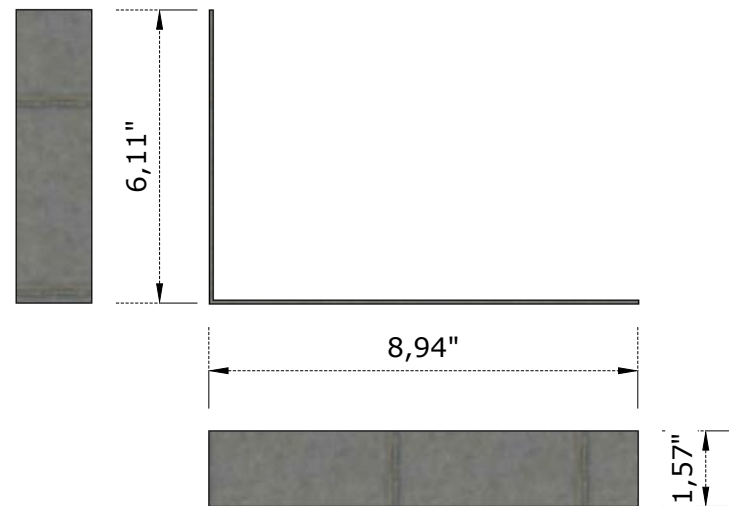

Coffre 17

C x2

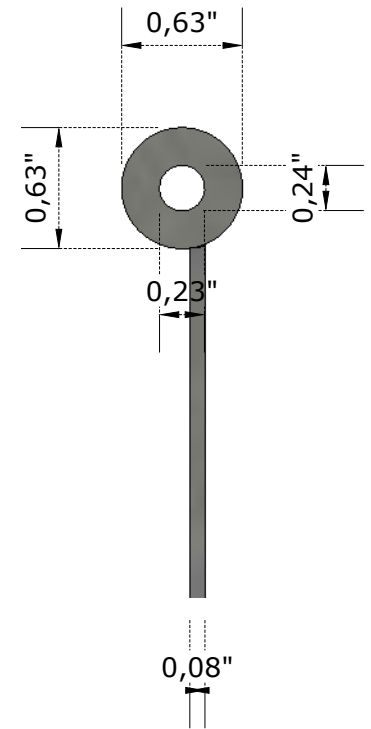
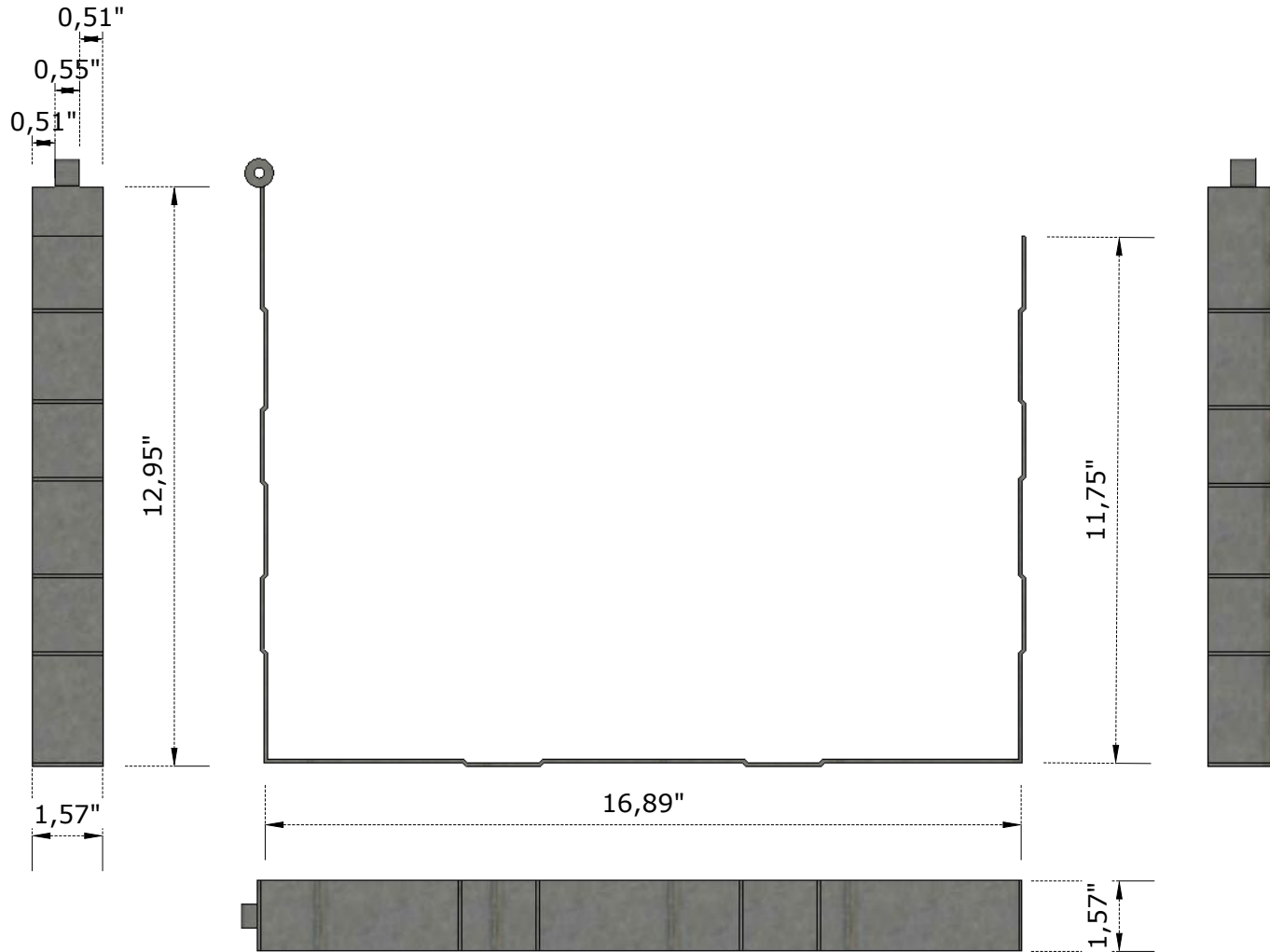
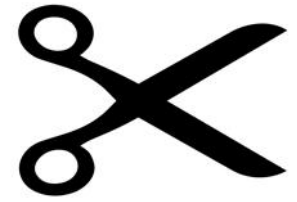

Coffre 17

D

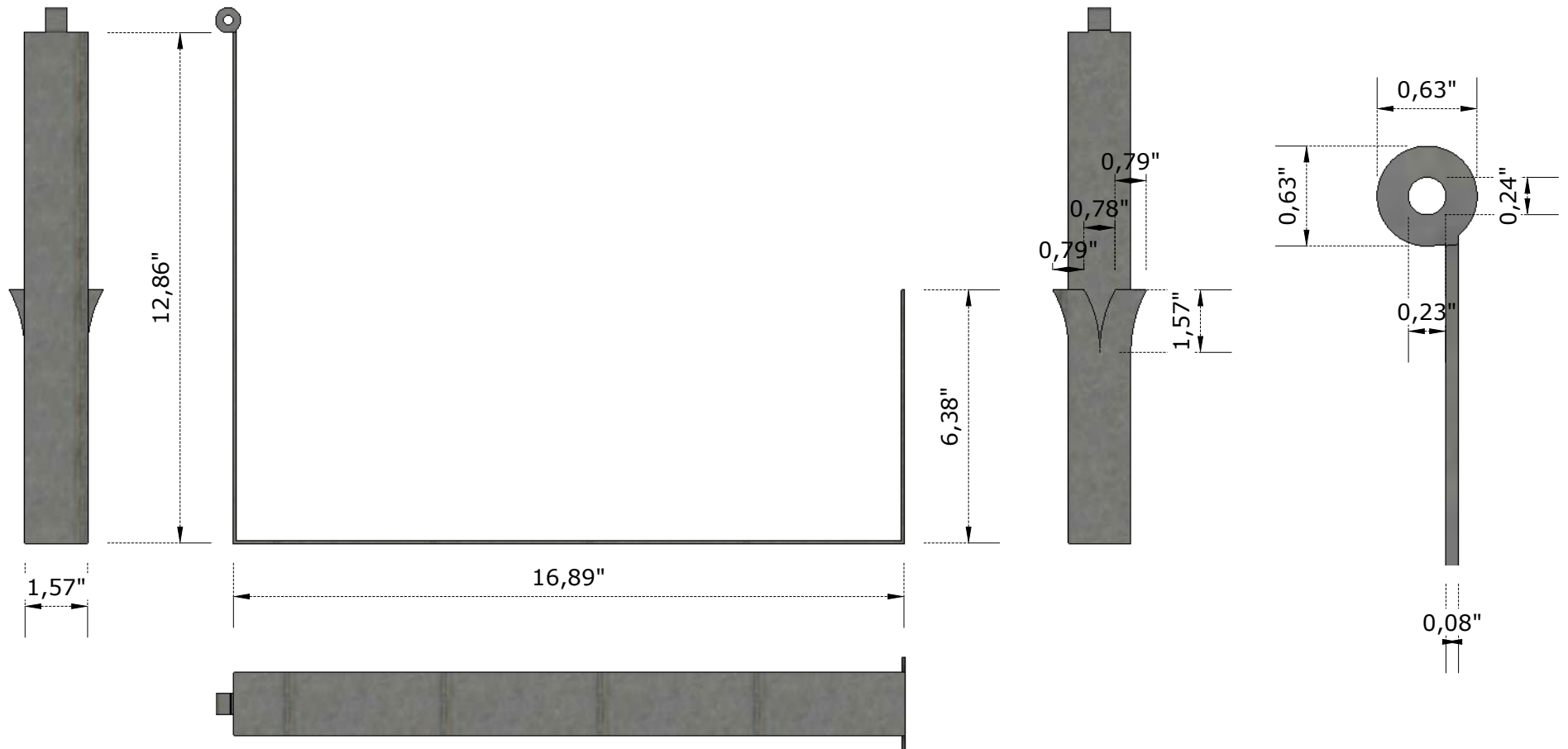
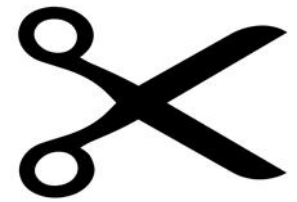

Coffre 17

E

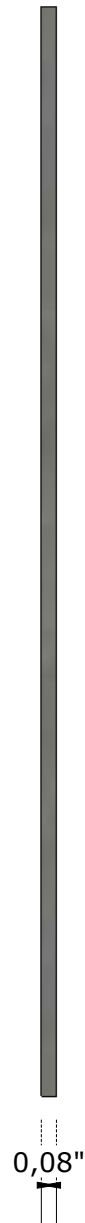
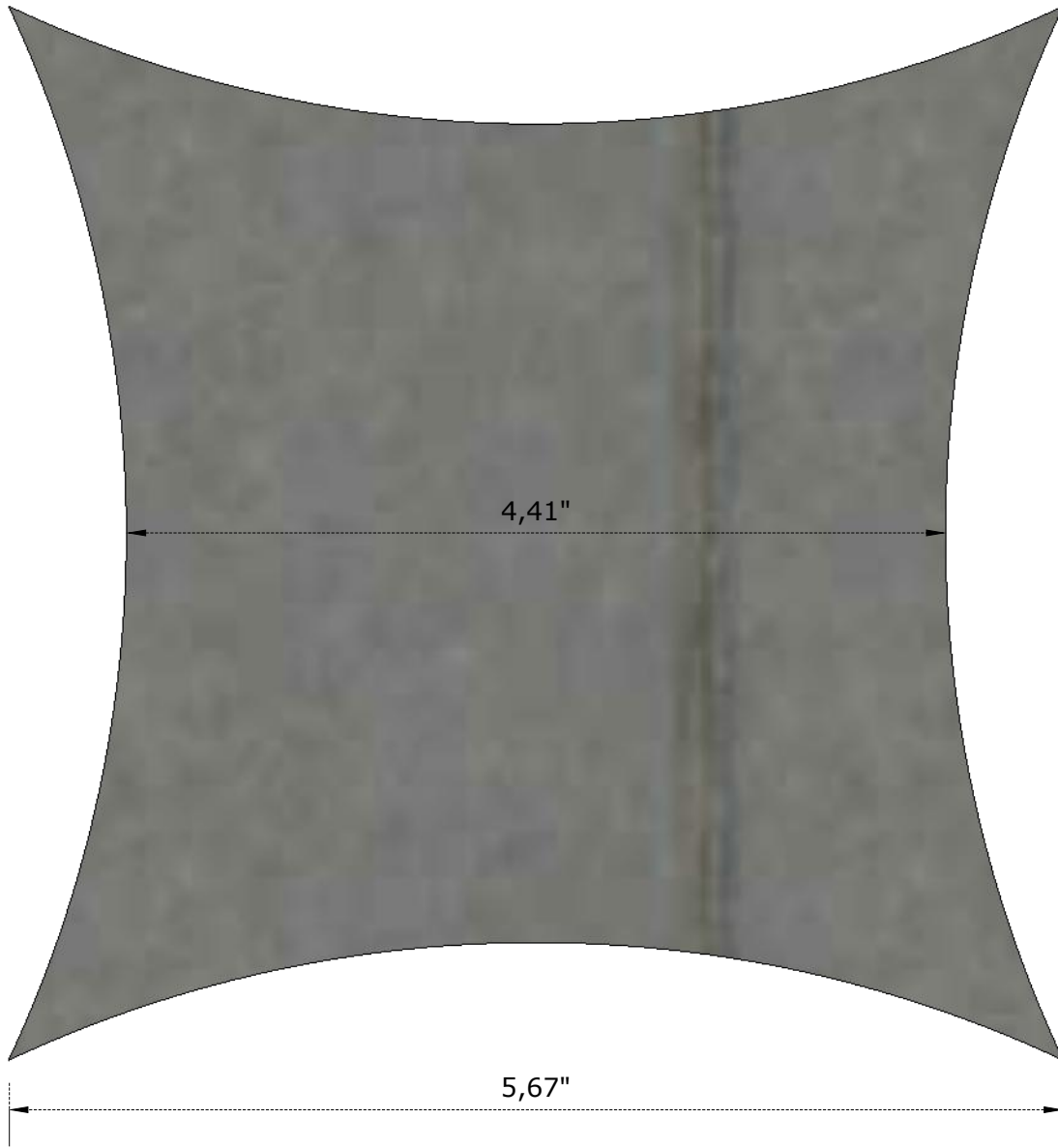
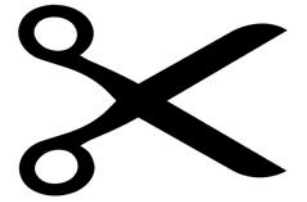

Coffre 17

F

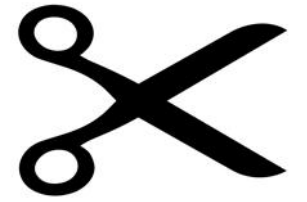
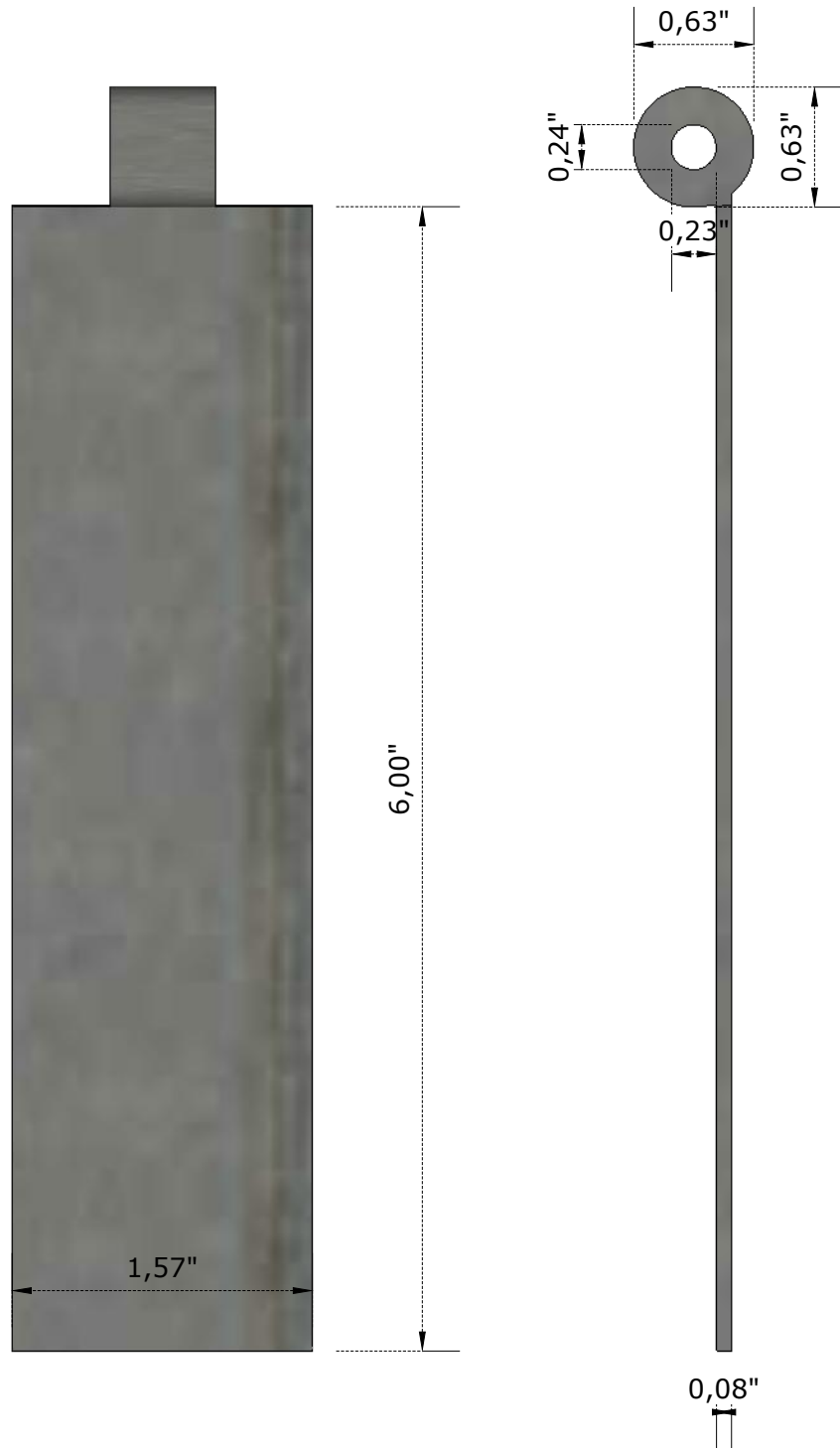

Coffre 17

G x2

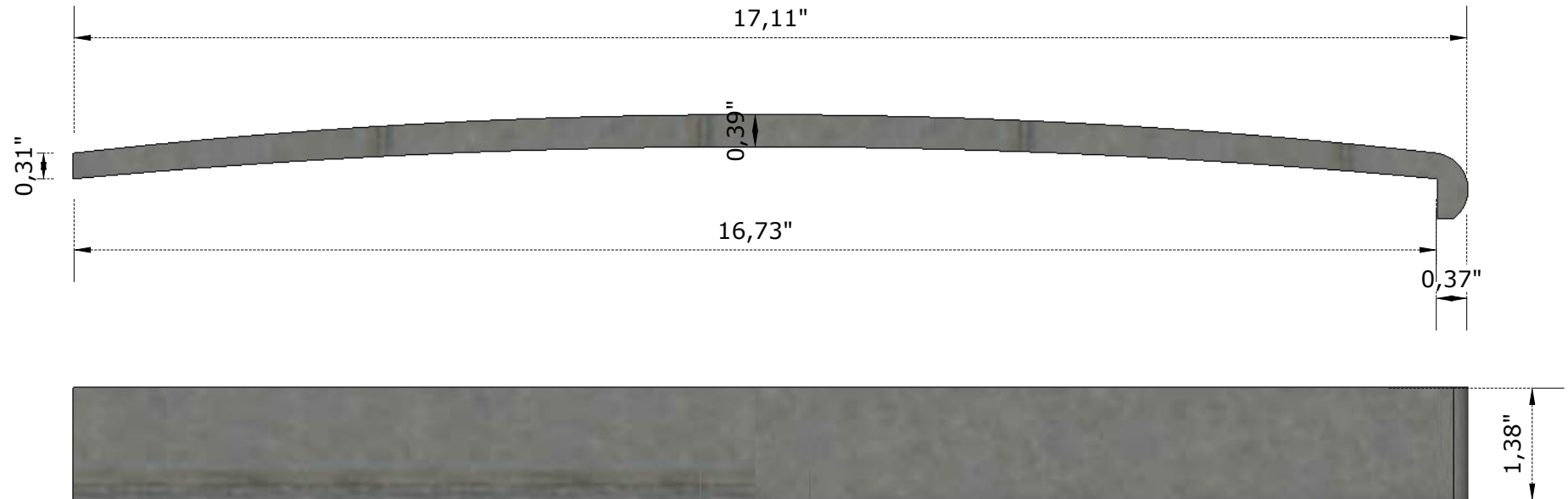

Coffre 17

H x2

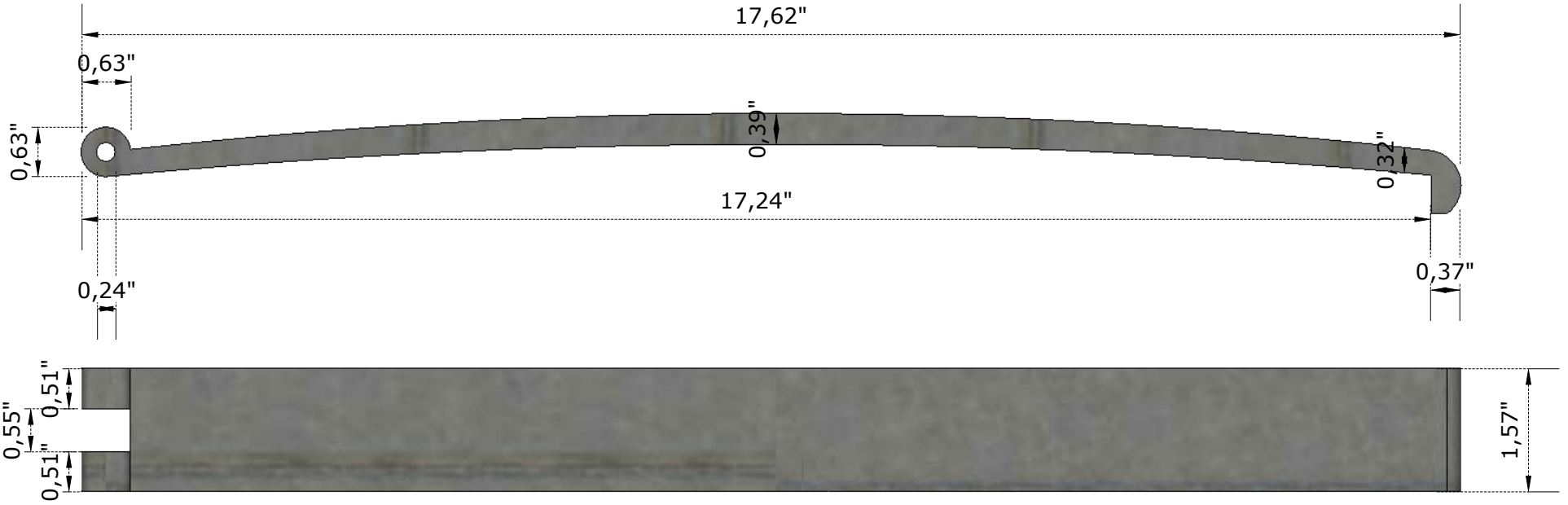

Coffre 17

H

